



Datasheet

ALTERA C 10.7.5

Coordinate Measuring Machine



Model shown: Altera C 10.7.5 with optional integrated controller and monitor arm.

TECHNICAL DATA | Dimensions

ALTERA C
10.7.5

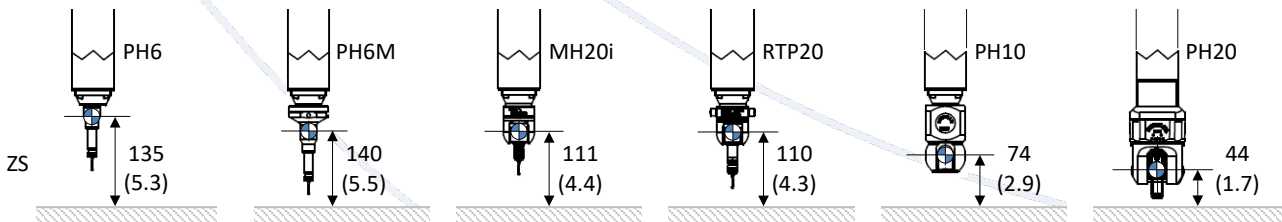
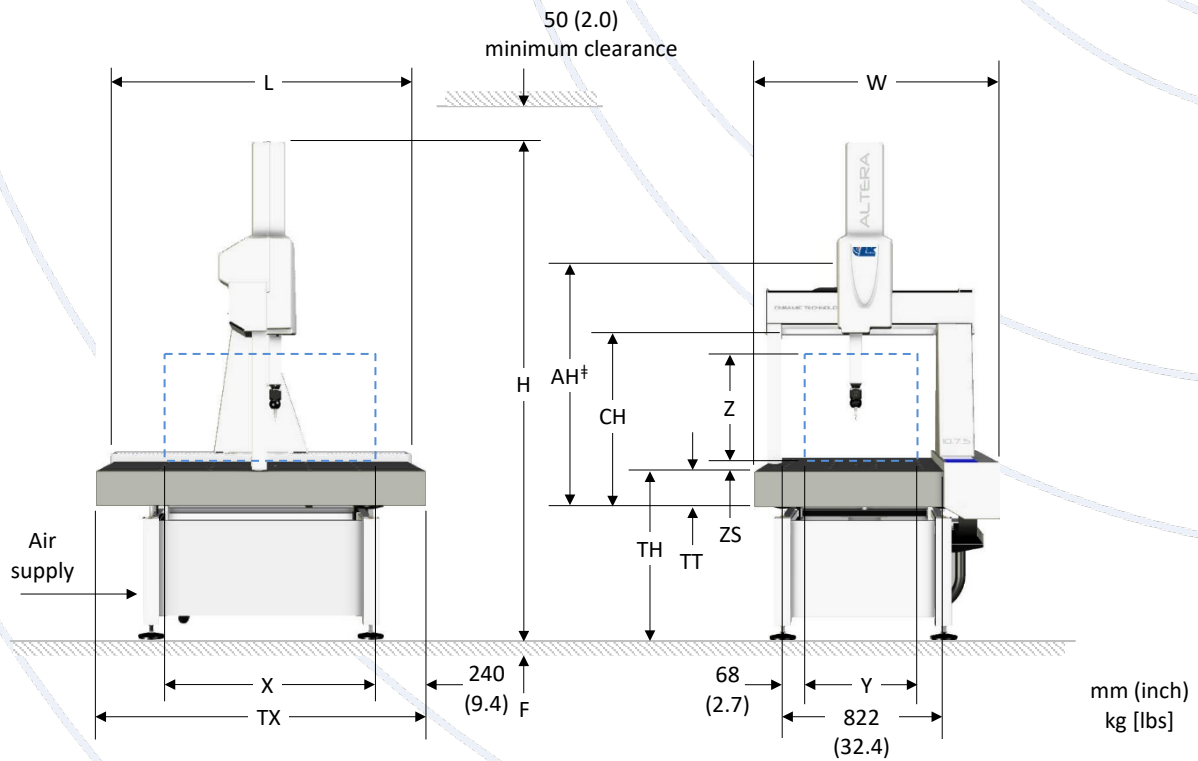

	Travels ¹			Overall			Granite Table					Floor ²	Clearance	Access	Table Loading		CMM
	X	Y	Z	L	W	H	TX	TT	TH	HX	HY	F	CH	AH [‡]	Std.	Max. ³	Weight
10.7.5	1000 (39)	650 (26)	500 (20)	1660 (65.4)	1180 (46.5)	2533 (99.7)	1630 (64.2)	170 (6.7)	840 (33.1)	350 (13.8)	120 (4.7)	55 (2.2)	688 (27.1)	1335 [2943]	315 [694]	700 [1543]	1104 [2434]

¹Maximum travel of probe head reference point.
²Minimum thickness of homogeneous concrete floor with minimum shear strength of 0.4 N/mm² (58 psi).
³Maximum table loading only permissible with workpiece positioned inside area defined by Table Support Centres.
⁴Height of bridge assembly for installation access excluding lifting equipment and clearances.

TABLE SUPPORT CENTRES

	P	R	S	T
10.7.5	1365 (53.7)	910 (35.8)	265 (10.4)	120 (4.7)

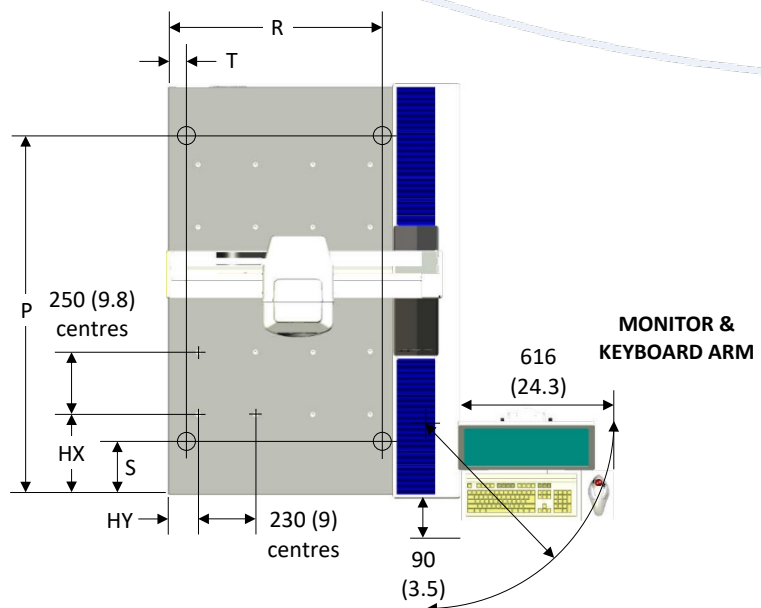

TOUCH PROBE ACCURACY ¹		TP20 ² PH10T/M PLUS MH20i/RTP20 PH6/PH6M	T200 ³ PH10T/M PLUS PH6/PH6M	SP25M ⁴ PH10M PLUS PH6M	PH20 ²
ISO 10360 -2:2009					
Length measurement at 18°C to 22°C	E0 MPE E150 MPE	2.5+L/333	2.2+L/333	2.2+L/333	3.0+L/333
Repeatability	R0 MPL	1.5	1.5	1.5	2.0
ISO 10360 -4:2001					
Probing accuracy scanning mode	form MPE T _{ij} time MPT t	-	-	4.0 59 sec	-
ISO 10360 -5:2010					
Probing accuracy touch mode	form PFTU MPE	2.5	2.2	2.2	2.5

LASER SCANNER ACCURACY⁶

ISO 10360 -8:2013		LC15Dx	LC60Dx	L100	XC65Dx	XC65Dx-LS
Probing form	PForm.Sph.1x25 :Tr:ODS,MPE	7	20	15	25	35
Probing dispersion	PForm.Sph.D95% :Tr:ODS,MPL	7.6	36	26	48	60
Probing size All	PSize.Sph.All :Tr:ODS,MPE	15	30	20	45	80
Cone angle		100	125	125	115	125

DYNAMICS

Acceleration	1800 mm/sec ²
Velocity	500 mm/sec

Conformance is proven when all errors of indication lie within or on the accuracy specification limits MPE/MPL.

Conformance is unproven when one or more errors of indication lie outside the accuracy specification limits MPE/MPL.

¹ Touch probe accuracy specifications using manufacturer specified test lengths and test sphere with empirical qualification.

E0 MPE E150 MPE

Maximum volumetric length measurement error in microns where L is the measured length in millimetres.

R0 MPL

Maximum repeatability value in microns using E0 values.

MPE T_{ij} MPT t

Maximum single stylus form error in microns using scanning mode with time taken in seconds.

PFTU MPE

Maximum single stylus form error in microns using touch point mode.





² TP20 standard force module, EM2 module (PH20 E_n MPE only), Ø4x10mm stainless steel shaft stylus, Ø4x30mm tungsten carbide shaft stylus (E_n MPE only), Ø5x20mm star tungsten carbide shaft stylus (P*TM MPE only), touch velocity 0.1m/min, approach 10mm (E_n MPE only), 7mm (PFTU MPE only), 25-point probe qualification with pre-travel variation compensation (R0 MPL).

³ TP200 standard force module, Ø4x10mm stainless steel shaft stylus, Ø4x30mm tungsten carbide shaft stylus (E_n MPE only), Ø5x20mm star tungsten carbide shaft stylus (P*TM MPE only), touch velocity 0.1m/min, approach 10mm (E_n MPE only), 7mm (PFTU MPE only).

⁴ SP25M SM25-1 module, SH25-1 stylus holder, Ø4x50mm tungsten carbide shaft stylus, Ø3x21mm stainless steel shaft stylus (P*TM MPE only), touch velocity 0.1m/min, scanning velocity 0.5m/min, approach 10mm (E_n MPE only), 7mm (PFTU MPE only), 50 UPR 2σ filter.

TECHNICAL DATA | Touch Trigger

ALTERA C
10.7.5

PROBE HEADS	PH6		MH20i		RTP20		PH10T PLUS		PH20	
										
Head type	Fixed (Vertical)		Manual Indexing		Automatic Indexing		Motorised Indexing		5-Axis Continuous	
Head positions	-		168		168		720		Infinite	
Angular tilt	-		0° to +90° in 15° steps		0° to +90° in 15° steps		0° to +105° in 7.5° steps		±115°	
Angular rotation	-		±180° in 15° steps		±180° in 15° steps		0° to ±180° in 7.5° steps		Infinite	
TOUCH PROBES	TP20		TP200		Integral		Integral		Integral	
Min. stylus diameter	0.3 (0.012)		0.3 (0.012)		0.3 (0.012)		0.3 (0.012)		0.3 (0.012)	
Max. stylus length	60 (2.4)		100 (3.9)		60 (2.4)		60 (2.4)		60 (2.4)	
Max. probe extension	300 (11.8)		300 (11.8)		300 (11.8)		300 (11.8)		300 (11.8)	
Min. probing force	0.055N		0.02N		0.055N		0.055N		0.055N	
Stylus change rack	MCR20		SCR200		MCR20		MCR20		SCR200	
PERIPHERALS										
Controller	NMC100		NMC100		NMC100		NMC100		UCC-T5	
Handbox	SOLO		SOLO		SOLO		SOLO		MCU-5	
- Not available									mm (inch)	

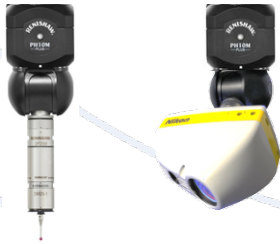
PROBE HEADS		PH6M			PH10M PLUS			
								
Head type		Fixed (Vertical)			Motorised Indexing			
Head positions		-			720			
Angular tilt		-			0° to +105° in 7.5° steps			
Angular rotation		-			0° to ±180° in 7.5° steps			
Probe change rack		MRS ACR3			MRS ACR3			
TOUCH PROBES		TP20	TP200	SP25M	TP20	TP200	SP25M	
Probe type		Touch trigger	Touch trigger	Scanning	Touch trigger	Touch trigger	Scanning	
Min. stylus diameter		0.3 (0.012)	0.3 (0.012)	0.5 (0.02)	0.3 (0.012)	0.3 (0.012)	0.5 (0.02)	
Max. stylus length		60 (2.4)	100 (3.9)	400 (15.7)	60 (2.4)	100 (3.9)	400 (15.7)	
Max. probe extension		300 (11.8)	300 (11.8)	100 (3.9)	300 (11.8)	300 (11.8)	100 (3.9)	
Min. probing force		0.055N	0.02N	0.1N	0.055N	0.02N	0.1N	
Stylus change rack		MCR20	SCR200	FCR25	MCR20	SCR200	FCR25	
LASER SCANNERS		-			LC15Dx	LC60Dx	XC65Dx/-LS	L100
Laser line width					15 (0.6)	60 (2.4)	3x 65 (2.6)	100 (3.9)
Points/sec					70k	75k	75k	200k
Resolution					22µm	60µm	65µm	42µm
Standoff					68	125	107/202	135
PERIPHERALS								
Controller		NMC300			NMC300			
Handbox		SOLO			SOLO			
Rotary Table		●			●			
Automation		●			●			

● Optional

- Not available

mm (inch)

TECHNICAL FEATURES

X axis guideway	Granite dovetail guideway with bellows covers on primary bridge leg
Y axis guideway	Mono-crystalline alumina ceramic guideway 162 x 100mm (6.4 x 3.9inch)
Z axis guideway	Mono-crystalline alumina ceramic guideway 63.5 x 63.5mm (2.5 x 2.5inch) with top-hat cover
X axis friction drive	Chrome-plated hardened steel drive bar with preloaded V roller and DC servomotor
Y axis friction drive	Chrome-plated hardened steel drive bar with preloaded V roller and DC servomotor
Z axis friction drive	Chrome-plated hardened steel drive bar with preloaded V roller and DC servomotor
Linear encoders	0.05µm gold plated tape scale and optical read-head Renishaw VIONIC™ system
Counterbalance	Fully adjustable pneumatic Z axis counter balance
Granite table	Granite table flatness according to DIN 876
Table inserts	Grid of M10 x 1.5 threaded table inserts X-axis pitch 250mm (9.8inch) Y-axis pitch 230mm (9inch)
Air bearings	Single orifice multi-groove air bearings with 5µm air cushion on all axes
Temperature compensation	Automatic temperature compensation for work piece and all axes
Anti-vibration	Passive elastomer anti-vibration as standard, active pneumatic anti-vibration optional

ENVIRONMENTAL REQUIREMENTS

Ambient temperature	Standard temperature range: 18°C to 22°C
Temperature gradient	Standard temperature range: 1°C/h 2°C/24h 1°C/m
Operating temperature	10°C to 30°C
Relative humidity	20% to 80% non-condensing
Floor vibration	Passive anti-vibration: Max. 1.27µm peak-to-peak over 3.5 to 90Hz range Active anti-vibration: Specification on request

SUPPLY REQUIREMENTS

Power supply	115V/20A or 230V/13A 50 to 60Hz single phase regulated to within -5% to +10%
Air consumption	Passive anti-vibration: 3.3 SCFM (94 NI/min) Active anti-vibration: Specification on request
Air supply	Min. air supply pressure 6.2 bar (90 psi)
Air quality	Dew point: 2°C Air temperature: Within +/- 2°C of ambient temperature Solids: Max. particle size 1.0µm and max. concentration 1mg/cu.m of air Oil/hydrocarbons: Max. concentration 0.1mg/cu.m of air

WARRANTY



12 months' warranty as standard, extended warranty available on request
Unique 10-year original accuracy guarantee as standard
Terms and conditions apply see LK Metrology website for full details

CONFORMITY



Full CE certification in accordance with the following directives:
Machinery directive 2006/42/EC
Low voltage directive 2014/35/EC
Electromagnetic directive 2014/30/EC

VIONIC trademark of Renishaw PLC.

Copyright © 2020 LK Metrology. All Rights Reserved. For general information only and subject to change without prior notice.

ALTERA C 10.7.5 Datasheet (Jan2020) A1200919